



Version 1.0

Specifications are subject to change without notice

MT6302
Dual SIM Card Controller
Data Sheet

MT6302 Dual SIM Card Controller

Confidential Information

Revision: 1.0

Release Date: Nov, 20, 2007

Table of contents

Figures Index	3
Table Index	3
Features	4
Applications	4
General Description	4
Pin Configuration	4
Absolute Maximum Ratings	5
Electrical Characteristics	5
Pin Description	7
Detailed Description Overview	7
Serial Port Interface (SPI)	8
Register Definitions.....	9
Signal Processing Blocks	11
Analog Blocks	12
SIM Card Interface.....	12
Card Activation and Deactivation	12
Application Circuit Example	13
Package Information	14

Figures Index

Figure 1. MT6302 block diagram	7
Figure 2. SPI Interface Transfer Diagram.....	8
Figure 3. SPI Interface Timing Diagram	8

Table Index

Table 1. Truth table of SCLK	11
Table 2. Truth table of SRST	12

Dual SIM Card Controller

Features

- Control and communication through a SPI interface with baseband processor.
- Independent 1.8V/3V VCC control for each SIM card
- Power management and control for dual SIM cards
- Independent clock stop mode (at high or low level) for each SIM card
- Compatible with our baseband processor chips, MT6225, MT6223, MT6226, MT6227, MT6229, etc.
- 20-Pin 3mm x 3mm QFN Package

Applications

- Support dual SIM card interface
- GSM, Edge, GPRS and 3G Cellular Phones

General Description

The MT6302 is a dual SIM card control chip optimized for GSM handsets, especially those based on the MediaTek MT62xx system solution. It supports both 1.8V and 3V SIM cards. A serial port interface (SPI) is used to control dual SIM channel individually.

The MT6302 is available in 20-pin 3mm x 3mm QFN package. The operating temperature range is from -25°C to +85°C.

Ordering Information

ORDER NUMBER	MARKING	TEMP. RANGE	PACKAGE
MT6302	MT6302	-25°C to +85°C	QFN - 20L

Pin Configuration

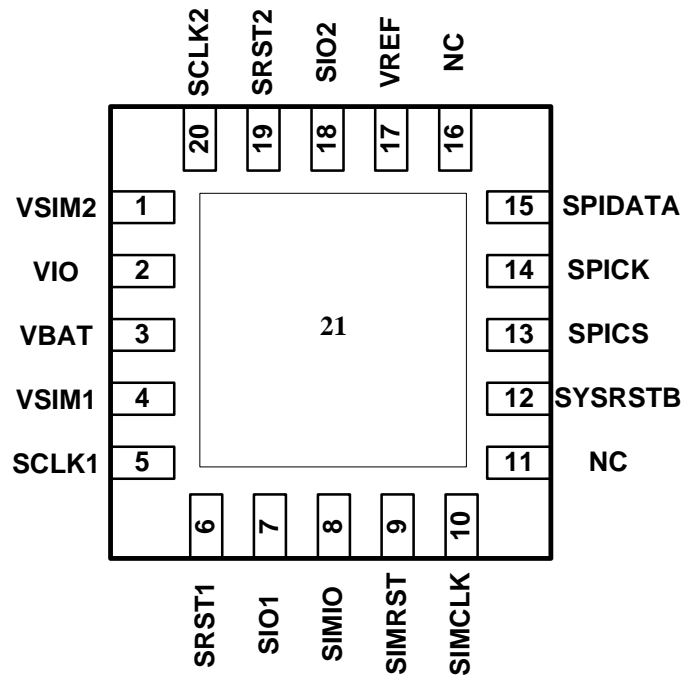



Specifications are subject to change without notice

Absolute Maximum Ratings

VREF relative to GND.....-0.3V to Vbat+0.3V Storage Temperature Range.....-65°C to +165°C
 All other pins relative to GND.....-0.3V to 7V Thermal Impedance, θ_{JA} (4 layer JEDEC PCB)....23°C/W
 Operating Temperature Ranges.....-25°C to +85°C Reflow Temperature (soldering, 10sec).....+260°C
 Maximum Junction Temperature+165°C

Stresses beyond those listed under "Absolute Maximum Ratings" may cause permanent damage to the device. These are stress ratings only, and functional operation of the device at these or any other conditions beyond those indicated in the operational sections of specifications is not implied. Exposure to absolute maximum rating conditions for extended periods may affect device reliability.

Electrical Characteristics

(VBAT=2.7V-5.5V, CVREF=CVSIM1=CVSIM2=2.2μF, minimum loads applied on all outputs, unless otherwise noted. Typical values are at TA=+25°C.)

Parameter	Condition	Min	Typical	Max	Unit
Input power supply					
VBAT Operating Voltage		2.7		5.5	V
VBAT Shutdown Current	VIO = 0V	---	0.1	1	μA
VBAT Operating Ground Current	VSIM1 = 3.0V, VSIM2 = 0V, no load	---	30	70	μA
	VSIM1 = 1.8V, VSIM2 = 0V, no load		30	70	
VIO Operating Voltage		2.6		3.2	V
VIO Shutdown Current		---	0.1	1	μA
VIO Operating Ground Current		---	3	10	μA
Input Control					
Low Input Threshold	SPIDATA, SPICK, SPICS, SYSRSTB			0.15*VIO	V
High Input Threshold	SPIDATA, SPICK, SPICS, SYSRSTB	0.85*VIO			V
SIM Card Supplies (VSIM1,VSIM2)					
1.8V Output Voltage		1.65	1.8	1.95	V
3.0V Output Voltage		2.82	3.0	3.18	V
Output Short Current Limit		---	38	---	mA
Load Regulation(1.8V)	0.05mA<I_load<20mA at Vbat=3.6V	---	1	10	mV
Load Regulation(3.0V)			1.7	10	
Line Regulation(1.8V)	3.6V<Vbat<5.5V	---	1.2	5	mV
Line Regulation(3.0V)				8	
Turn-On Time	No load, Enable to VSIM1,2 at 90% selected voltage		0.8	1.5	ms
GSM Interface					
Vih(SIMCLK,SIMRST)		Vio-0.6	---	---	V
Vil (SIMCLK,SIMRST)		---	---	0.6	V
Vil (SIMIO)	Vol ≤ 0.4V, Iol=1mA	---	---	0.23	V
	Vol ≤ 0.4V, Iol=0mA	---	---	0.335	
Vih(SIMIO) , Voh(SIMIO)	Iih,Ioh=± 20μA	Vio-0.6	---	---	V
Iil(SIMIO)	Vil=0V	---	---	-0.9	mA
Vol(SIMIO)	Vil=0.4V	---	---	0.42	V
Interface to 3 V SIM Card					
Vol(SRST)	Sink Current = -20 μA (VSIMRST = 0.6V)	---	---	0.4	V
Voh(SRST)	Source Current = 200 μA (VSIMRST = 0.9*VSIM	0.9*VSIM	---	---	V

Specifications are subject to change without notice

	Vio-0.6V)				
Vol(SCLK)	Sink Current = -20 μ A (VSIMCLK = 0.6V)	---	---	0.4	V
Voh(SCLK)	Source Current = 200 μ A (VSIMCLK = Vio-0.6V)	0.9*VSIM	---	---	V
Vil(SIO)		---	---	0.15*VSIM	V
Vih(SIO) , Voh(SIO)	Source Current = 20 μ A	VSIM-0.4	---	---	V
Iil(SIO)	VSIO = 0 V	---	---	-1	mA
Vol(SIO)	Sink Current = -1 mA (VSIMIO = 0 V)	---	---	0.15*VSIM	V
Interface to 1.8 V SIM Card					
Vol(SRST)	Sink Current = -20 μ A (VSIMRST = 0.6V)			0.2*VSIM	V
Voh(SRST)	Source Current = 200 μ A (VSIMRST = Vio-0.6V)	0.9*VSIM			V
Vol(SCLK)	Sink Current = -20 μ A (VSIMCLK = 0.6V)			0.2*VSIM	V
Voh(SCLK)	Source Current = 200 μ A (VSIMCLK = Vio-0.6V)	0.9*VSIM			V
Vil(SIO)				0.15*VSIM	V
Vih(SIO) , Voh(SIO)	Source Current = 20 μ A	VSIM-0.4			V
Iil(SIO)	VSIO = 0 V			-1	mA
Vol(SIO)	Sink Current = -1 mA (VSIMIO = 0 V)			0.15*VSIM	V
SIM Card Interface Timing					
SRST, SIO rise/fall times	VSIM = 3, 1.8 V, loaded with 30 pF (10%~90%)			1	μ s
SCLK rise/fall times	VSIM = 3 V, loaded with 30 pF (10%~90%)			18	ns
	VSIM = 1.8 V, loaded with 30 pF (10%~90%)			50	ns
SCLK frequency		5			MHz
SCLK duty cycle	SIMCLK Duty = 50%, fSIMCLK = 5 MHz	47		53	%
SCLK propagation delay	From SIMCLK to SCLK		30	50	ns

Specifications are subject to change without notice

Pin Description

PIN	NAME	FUNCTION
1	VSIM2	SIM2 Supply
2	VIO	Digital IO Supply
3	VBAT	Battery Input Voltage
4	VSIM1	SIM1 Supply
5	SCLK1	Level-Shifted SIM1 Clock Output
6	SRST1	Level-Shifted SIM1 Reset Output
7	SIO1	Level-Shifted SIM1 Bidirectional Data Input/Output
8	SIMIO	Non-Level-Shifted Bidirectional Data I/O
9	SIMRST	Non-Level-Shifted SIM Reset Input, Internal Pull High to VIO
10	SIMCLK	Non-Level-Shifted SIM Clock Input
11	NC	
12	/SYSRSTB	System Reset, Low Active
13	SPICS	Serial bus selection
14	SPICK	Serial bus clock
15	SPIDATA	Serial bus data
16	NC	
17	VREF	Reference Voltage Output
18	SIO2	Level-Shifted SIM2 Bidirectional Data Input/Output
19	SRST2	Level-Shifted SIM2 Reset Output
20	SCLK2	Level-Shifted SIM2 Clock Output
21	GND	Ground

Detailed Description Overview

The MT6302 is a dual SIM card control chip optimized for use with GSM baseband chipsets in handset applications. Figure 1 shows the block diagram of the MT6302.

The MT6302 contains several blocks:

- **Serial Port Interface (SPI)**
- **Signal Processing Blocks**
- **Analog Blocks**
- **SIM Card Interface**

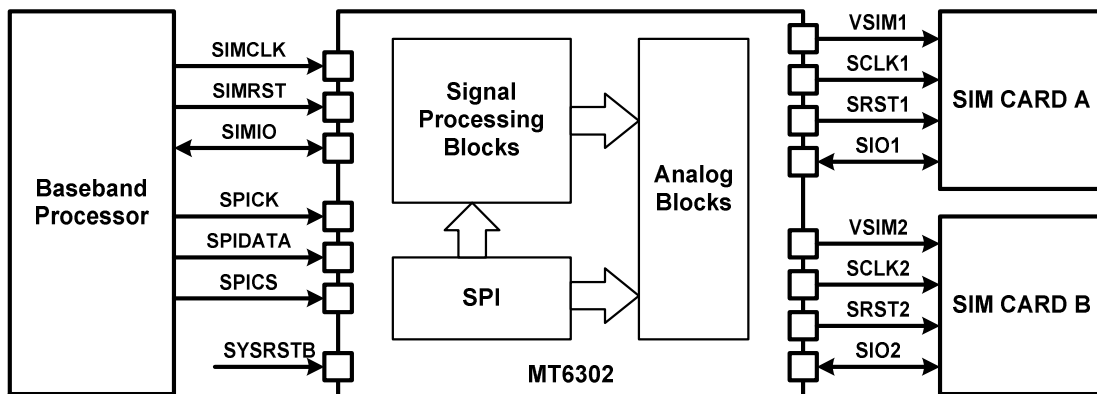

Figure 1. MT6302 block diagram

Specifications are subject to change without notice

Details of the individual subsystems and blocks are described in following Chapters.

Serial Port Interface (SPI)

This module is used to receive the commands transmitted by baseband processor. It will decode the received data and send corresponding commands to signal processing and analog blocks. The 8-bit serial interface uses three pins – SPICK#, SPIDATA and SPICK – to enter data. Data read is not available with the serial interface and data entered must be 8 bits. The description of three pins is:

Signal Name	Attribute	Direction	Description
SPICK	Edge Triggered	BB-> MT6302	Serial bus clock
SPIDATA	Level	BB-> MT6302	Serial data
SPICS	Active Low	BB-> MT6302	SPI bus selection

Figure2 shows the timing diagram of this serial interface. When the block is idle, SPICK is forced LOW and SPICS# is forced HIGH. Once the data register contains data and the interface is enabled, SPICS# is pulled LOW and remains LOW for the duration of the transmission. The first three bits are address bits and the others are data bits.

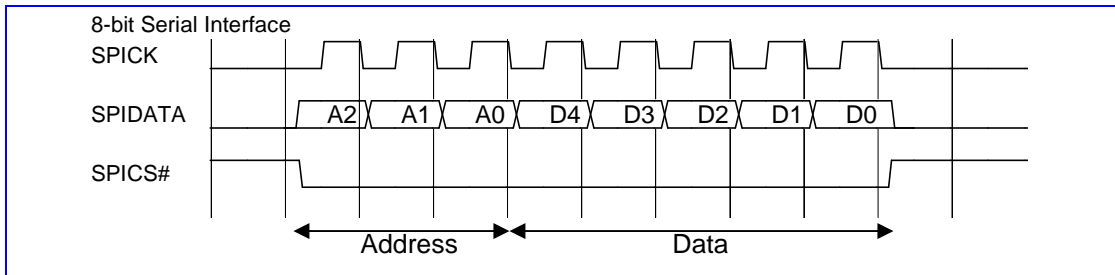

Figure 2. SPI Interface Transfer Diagram

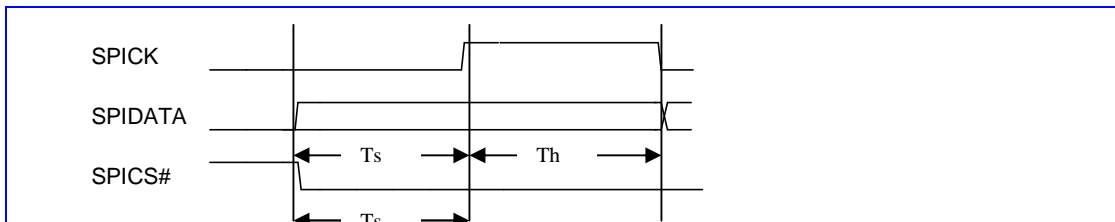

Figure 3. SPI Interface Timing Diagram

Serial Port Interface Timing

Symbol	Parameter	Min	Typ	Max	Unit
Ts	SPIDATA to SPICK setup time	4			ns
Th	SPIDATA to SPICK hold time	4			ns

Register Definitions

0000H Reset control Register

Bit	4	3	2	1	0
Name		RSTVAL		RSTSEL	
Type		WO	WO	WO	WO
Reset		0	0	0	0

The LSB of these two signals is for 1st SIM card, and MSB is for 2nd one.

RSTSEL SIM card RST pin control, only valid when **VCCEN** is 1.

- 0** The RST pin of SIM card is the same as MT6302 input pin SIMRST.
- 1** The RST pin of SIM card is controlled by **RSTVAL** as show below.

RSTVAL Control the value of SIM card RST pin, only valid when **VCCEN** is 1 and **RSTSEL** is 1.

- 0** Force the SIM card RST pin to 0.
- 1** Force the SIM card RST pin to 1.

0001H Clock Control Register

Bit	4	3	2	1	0
Name		CPOH		CPOL	
Type		WO		WO	
Reset		0	0	1	1

The LSB of these two signals is for 1st SIM card, and MSB is for 2nd one. The value of SIM card CLK pin is controlled by the combination of the two signals when **VCCEN** is 1.

CPOH, CPOL

- 01** The CLK pin of SIM card is the same as MT6302 input pin SIMCLK.
- 11** Force the SIM card CLK pin to stop at high.
- 00** Force the SIM card CLK pin to stop at low.
- 10** Not allowed.

0002H Data Control Register

Bit	4	3	2	1	0
Name		DATA_L		DATAEN	
Type		WO		WO	
Reset		0	0	0	0

The LSB of these two signals is for 1st SIM card, and MSB is for 2nd one.

DATAEN SIM card DATA pin control, only valid when **VCCEN** is 1.

- 0** The channel between SIM card DATA pin and MT6302 I/O pin SIMDATA will be gapped. If there were no drivers of these two pins, then they will be pulled high.
- 1** The channel between SIM card DATA pin and MT6302 I/O pin SIMDATA will be opened. If there were no drivers of these two pins, then they will be pulled high.

DATA_L Control the value of SIM card DATA pin, only valid when both **VCCEN** and **DATAEN** are '1'.

Specifications are subject to change without notice

- 0 normal function.
- 1 Force the SIM card DATA pin to 0.

0003H VCC Control Register

Bit	4	3	2	1	0
Name		VCCEN		VSEL	
Type		WO		WO	
Reset		0	0	0	0

The LSB of these two signals is for 1st SIM card, and MSB is for 2nd one.

VCCEN SIM card power control.

- 0 Turn off SIM card VCC pin, all signals to SIM card will be 0.
- 1 Turn on SIM card VCC pin.

VSEL Choose the supply voltage level of SIM card.

- 0 Supply voltage is 1.8V.
- 1 Supply voltage is 3V.

0004H

Bit	4	3	2	1	0
Name	REFSEL				
Type	WO				
Reset	0				

REFSEL LDO reference selection

- 0 VIO
- 1 Bandgap

0005H Bandgap Control Register

Bit	4	3	2	1	0
Name	BG_EN	RGBSEL			
Type	WO	WO			
Reset	0	0	0		

BG_EN Embedded bandgap enable

- 0 Disable
- 1 Enable

RGBSEL Bandgap T.C. fine turning

- 00 initial setting
- 01 minus 1 step
- 10 plus 1 step
- 11 plus 2 step

Specifications are subject to change without notice

Signal Processing Blocks

The main function of this block is to handle the command ordered by baseband processor about SCLK and SRST. When it receives commands sent by SPI, it will do the corresponding signal processing, and then sent the results to analog blocks. The commands is transmitted through serial port interface (SPI) and stored in the register set. Signal processing blocks will process signals with corresponding commands. The truth table of SCLK and SRST is shown in the following tables.

VSIM	CPOH	CPOL	SIMCLK	SCLK
0	0	0	0	0
0	0	0	1	0
0	0	1	0	0
0	0	1	1	0
0	1	0	0	0
0	1	0	1	0
0	1	1	0	0
0	1	1	1	0
1	0	0	0	0
1	0	0	1	0
1	0	1	0	0
1	0	1	1	1
1	1	0	0	Not allowed
1	1	0	1	Not allowed
1	1	1	0	1
1	1	1	1	1

Table 1. Truth table of SCLK

VSIM	RSTSEL	RSETVAL	SIMRST	SRST
0	0	0	0	0
0	0	0	1	0
0	0	1	0	0
0	0	1	1	0
0	1	0	0	0
0	1	0	1	0
0	1	1	0	0
0	1	1	1	0

Specifications are subject to change without notice

1	0	0	0	0
1	0	0	1	1
1	0	1	0	0
1	0	1	1	1
1	1	0	0	0
1	1	0	1	0
1	1	1	0	1
1	1	1	1	1

Table 2. Truth table of SRST

It will be noticed that the effect of those controlled signal may not be valid immediately due to the delay of some processing time.

Analog Blocks

This module contains SIM LDO, level shifter and bandgap function. It will accept the command set by SPI and also transfer the signals to suitable voltage level to SIM cards. The SIM LDO is a regulator that could source 20mA (max) with 1.8V or 3.0V output voltage selection based on the supply specs of subscriber identity modules (SIM) card.

SIM Card Interface

The SIM card interface circuitry of MT6302 meets all ETSI and IMT-2000 SIM interface requirements. It provides level shifting needs for low voltage GSM controller to communicate with either 1.8V or 3V SIM cards. All SIM cards contain a clock input, a reset input, and a bi-directional data input/output.

Card Activation and Deactivation

The role of MT6302 at card activation and deactivation is just a signal bypasser. It will bypass SIMCLK and SIMRST transmitted by baseband processor and turn on the channel between SIMIO and SIO.

When card activation, user just needs to follow the steps listed below.

- Set VSEL to desired level.
- Turn on VCCEN and DATAEN in sequence, and the other registers just keep their default settings.
- Turn on SIM interface of baseband processor to start activation sequence.

Similarly, when card deactivation, user just follows the steps listed below.

- Turn off SIM interface of baseband processor to start deactivation sequence.
- Set DATA_L and then turn off VCCEN, and the other registers just keep their default settings.

Specifications are subject to change without notice

Application Circuit Example

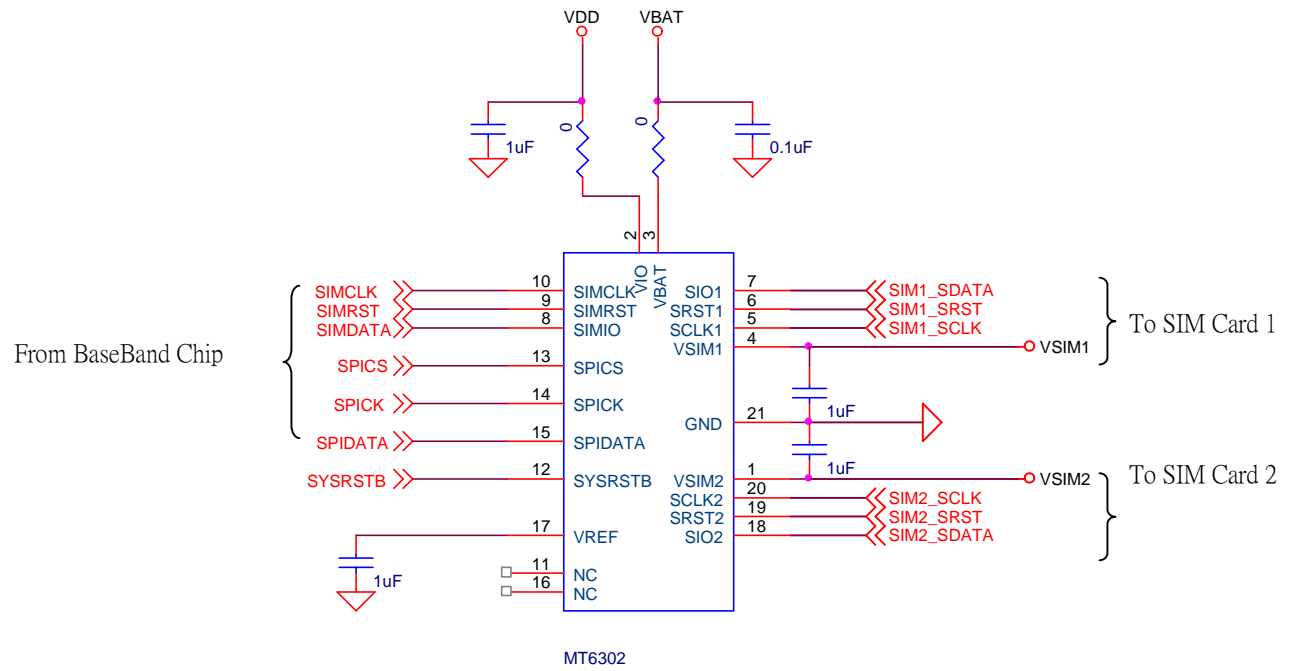

Specifications are subject to change without notice

Package Information

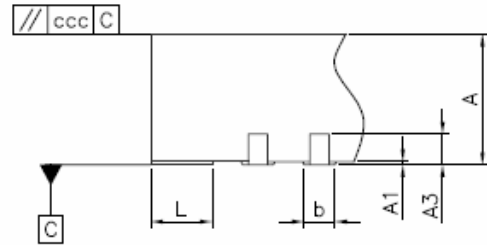
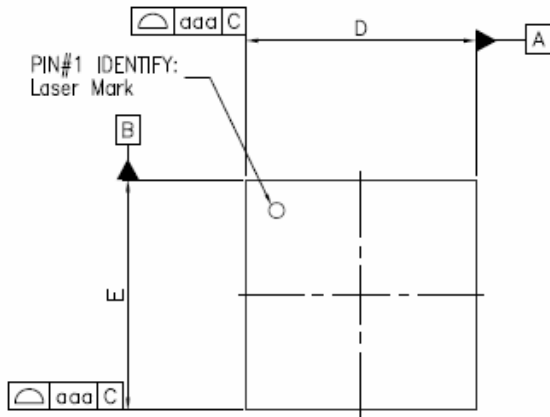

DETAIL : "B"

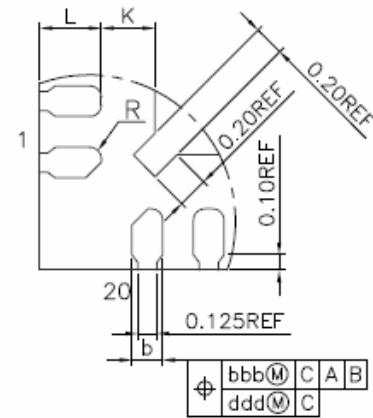
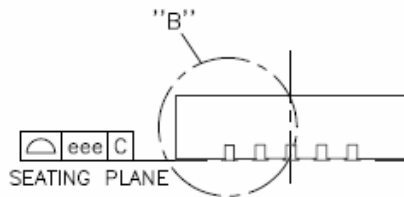

DETAIL : "A"

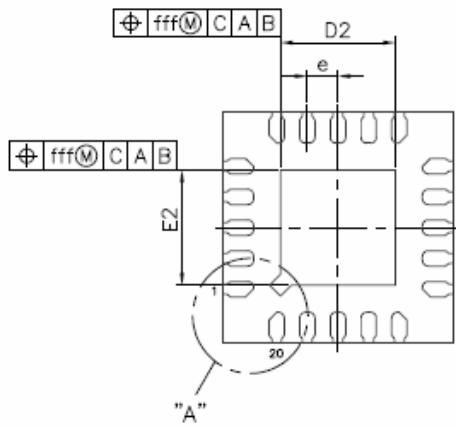

Specifications are subject to change without notice

Symbol	Dimension in mm			Dimension in inch		
	MIN	NOM	MAX	MIN	NOM	MAX
A	0.80	0.85	0.90	0.031	0.033	0.035
A1	0.00	0.02	0.05	0.000	0.001	0.002
A3	0.20 REF			0.008 REF		
b	0.15	0.20	0.25	0.006	0.008	0.010
D/E	3.00 BSC			0.118 BSC		
e	0.40 BSC			0.016 BSC		
L	0.30	0.40	0.50	0.012	0.016	0.020
K	0.20	----	----	0.008	----	----
R	0.075	----	----	0.003	----	----
aaa	----	----	0.10	----	----	0.004
bbb	----	----	0.07	----	----	0.003
ccc	----	----	0.10	----	----	0.004
ddd	----	----	0.05	----	----	0.002
eee	----	----	0.08	----	----	0.003
fff	----	----	0.10	----	----	0.004

L/F	Exposed Pad Size						Internal Pad Size					
	D2/E2 (mm)			D2/E2 (inch)			(mm)			(inch)		
	MIN	NOM	MAX	MIN	NOM	MAX	MIN	NOM	MAX	MIN	NOM	MAX
①	1.35	1.50	1.65	0.053	0.059	0.065	1.65	1.80	1.95	0.065	0.071	0.077

深圳市诚至微科技有限公司长期特价供应MT6302
电话：0755-83328582 <http://www.czwtech.com/>